

PIPE: A1
3mm dia.
Length 70mm
Ringed

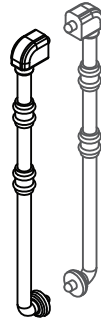

PIPE: A2
4mm dia.
Length 70mm
Ringed

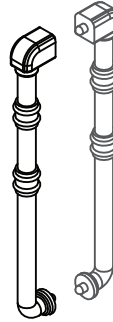

PIPE: B1
3mm dia.
Length 70mm
Flange & Ring

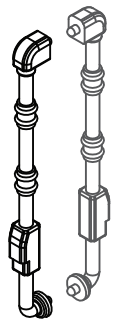

PIPE: B2
4mm dia.
Length 70mm
Flange & Ring

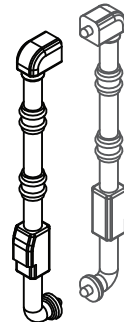

PIPE: C1
3mm dia.
Length 70mm
Plain



PIPE: D1
4mm dia.
Length 70mm
60° S-Bend

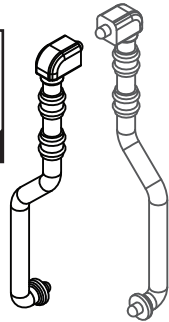

PIPE: E1
2mm dia.
Length 50mm
90° S-Bend

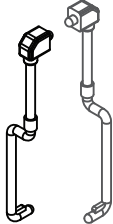

PIPE: F1
2mm dia.
Length 40mm
30° S-Bend

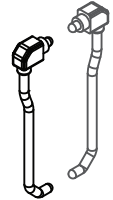

PIPE: G1
3mm dia.
Length 30mm
90° Bend

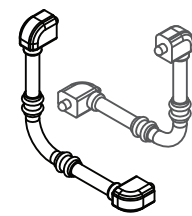

PIPE: G2
3mm dia.
Length 40mm
90° Bend

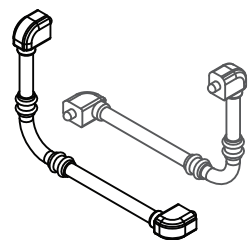

PIPE: H1
4mm dia.
Length 60mm, 45°
Branched Bend

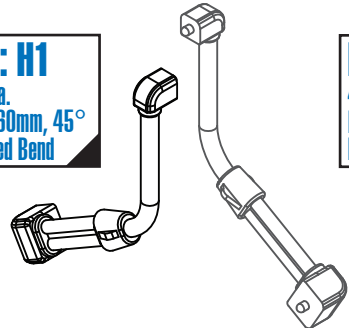

PIPE: I1
4mm > 3mm dia.
Length 60mm
Ringed

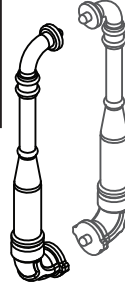

PIPE: J1
10mm dia.
Length 70mm
60° Bend

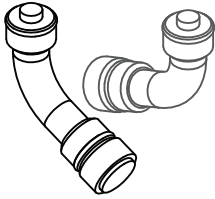

PIPE: J2
10mm dia.
Length 30mm
90° Bend

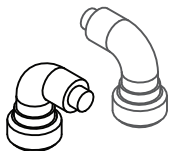

PIPE: K1Left
2mm dia.
Length 20mm
90° Bends

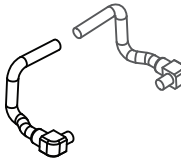

PIPE: K2Right
2mm dia.
Length 20mm
90° Bends

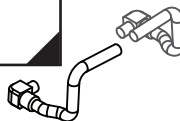

PIPE: L1Left
3mm dia.
Length 20mm
90° & 45° Bend

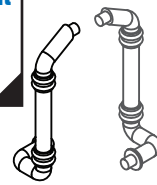

PIPE: L2Right
3mm dia.
Length 20mm
90° & 45° Bend

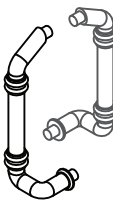

PIPE: M1Left
3mm dia.
Length 40mm
60° & 90° Bends

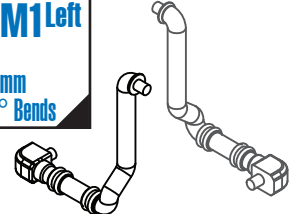

PIPE: M2Right
3mm dia.
Length 40mm
60° & 90° Bends

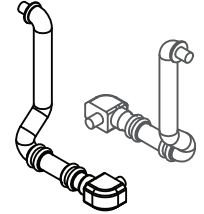

HOSTILE REALMS™



Wild House Models is a division of White Hart Media Limited, United Kingdom
Copyright 2015, All Rights Reserved.
Hostile Realms™ is a registered Trademark. Designed, Made & Manufactured in the UK



A1 A2 B1 B2 C1 D1 E1 F1 G1 G2 H1 I1 J1 J2 K1 K2 L1 L2 M1 M2

www.wildhousemodels.com

